

INSTRUCTION MANUAL

CPDC SERIES

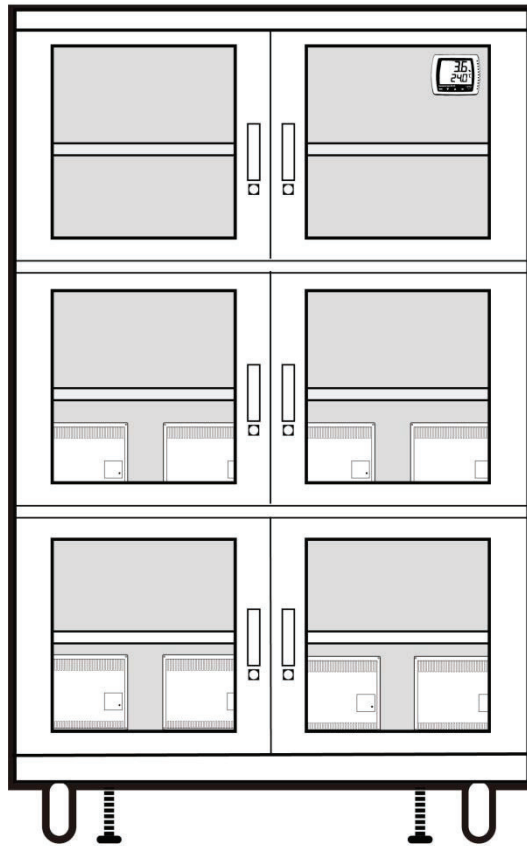

Thank you for purchasing the StatPro Dry Cabinet.

Please follow the instructions in this manual to correctly set up and use StatPro Dry Cabinet. Please retain this documentation throughout the lifetime of the equipment.

UPDATED MANUAL May 21, 2019 USE THIS MANUAL

CONTENTS

I. CHECK LIST OF ACCESSORIES	1
II. SAFETY GUIDANCE.....	2
III. STATPRO DRY CABINET COMPONENTS.....	2
IV. STATPRO DRY CABINET INSTALLATION AND ADJUSTMENT	3
V. DIGITAL THERMO-HYGROMETER BATTERY REPLACEMENT	5
VI. TROUBLESHOOTING	6
VII. SPECIFICATION	6

I. CHECK LIST OF ACCESSORIES

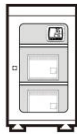

CPDC-1D

This product includes:

- 1 digital thermo-hygrometer,
- 2 height-adjustable anti-static shelves,
- 4 anti-static adjustable leveling support,

In the plastic bag:

- 1 instruction manual,
- 1 anti-static grounding wire,
- 1 key and 8 shelf clips



CPDC-2D

This product includes:

- 1 digital thermo-hygrometer,
- 3 height-adjustable anti-static shelves,
- 4 anti-static adjustable leveling support,

In the plastic bag:

- 1 instruction manual,
- 1 anti-static grounding wire,
- 2 keys and 12 shelf clips



CPDC-3D

This product includes:

- 1 digital thermo-hygrometer,
- 5 heavy-duty height-adjustable anti-static shelves,
- 4 anti-static adjustable leveling support,
- 4 anti-static casters

In the plastic bag:

- 1 instruction manual,
- 1 anti-static grounding wire,
- 3 keys and 20 shelf clips

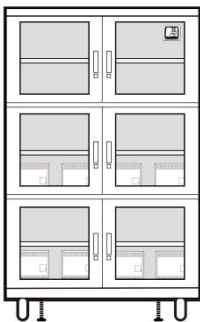

CPDC-6D

This product includes:

- 1 digital thermo-hygrometer,
- 5 heavy-duty height-adjustable anti-static shelves,
- 4 anti-static adjustable leveling support,
- 4 anti-static casters

In the plastic bag:

- 1 instruction manual,
- 1 anti-static grounding wire,
- 6 keys and 20 shelf clips

II. SAFETY GUIDANCE

- A. Do not disassemble the core unit to avoid serious injury and damage. In the event of any injuries occurred caused by disassembling the core unit, neither the seller nor the manufacturer will bear any responsibility. It will also void your warranty.
- B. Do not install the StatPro Dry Cabinet near air-conditioner vents, places with high temperature, smoke and dust, or a place with direct sunlight to prevent damages to the core unit and its performance.
- C. Do not operate the StatPro Dry Cabinet in a damp or wet environment. It may cause electric shock.
- D. Please only use 110V or 220V AC power source (alternating current) and do not share the same socket with other electrical devices (by using splitters).
- E. Do not store erosive, explosives, vapors or ignitable items in the StatPro Dry Cabinet to avoid causing a fire or explosion.
- F. Do not store any hydrochloric acid, sulfuric acid or other corrosive chemicals in the StatPro Dry Cabinet to avoid causing corrosion.
- G. Remove all stored items from the StatPro Dry Cabinet while moving it to prevent any damage.
- H. The glass doors of the drying cabinet may shatter upon impact.

III. STATPRO DRY CABINET COMPONENTS

- A. Components of cabinet

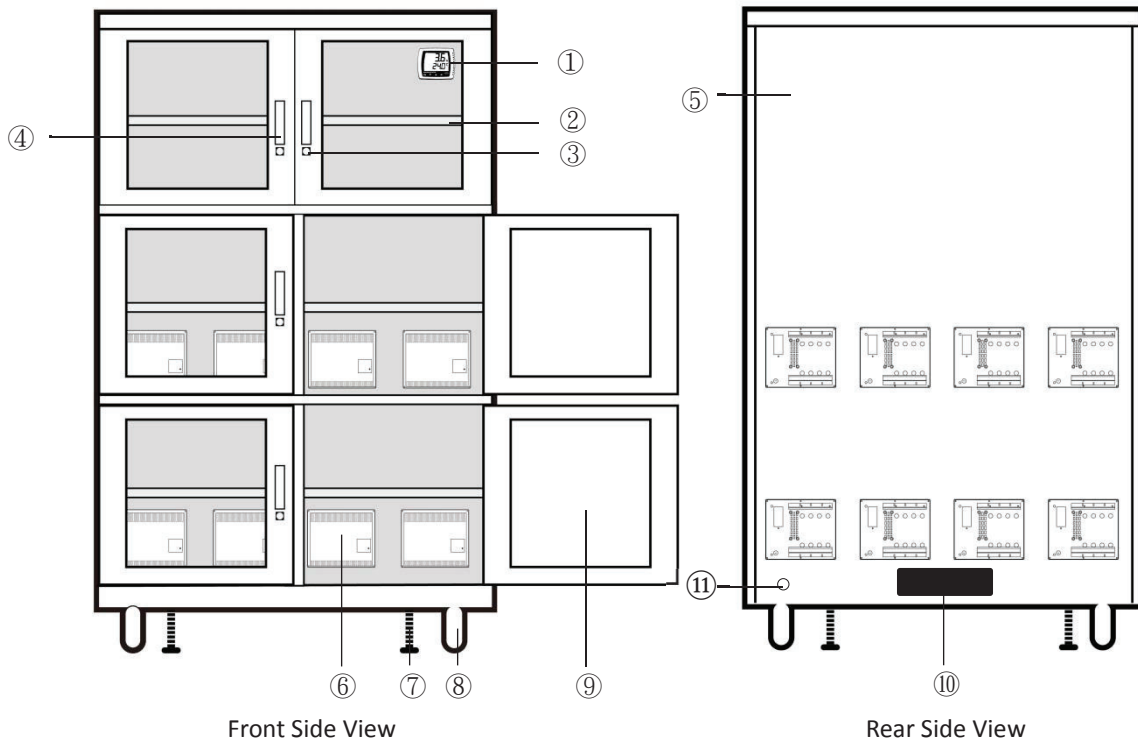

- ① Digital thermal-hygrometer
- ② Heavy duty anti-static shelf
- ③ Lock
- ④ Door handle
- ⑤ Anti-static coated cabinet
- ⑥ Automatic drying system (Core unit)
- ⑦ Adjustable leveling support
- ⑧ Anti-static caster
- ⑨ Anti-static glass
- ⑩ Power distributor
- ⑪ Connecting button for anti-static grounding wire

B. STATPRO DRY CABINET Automatic Drying System

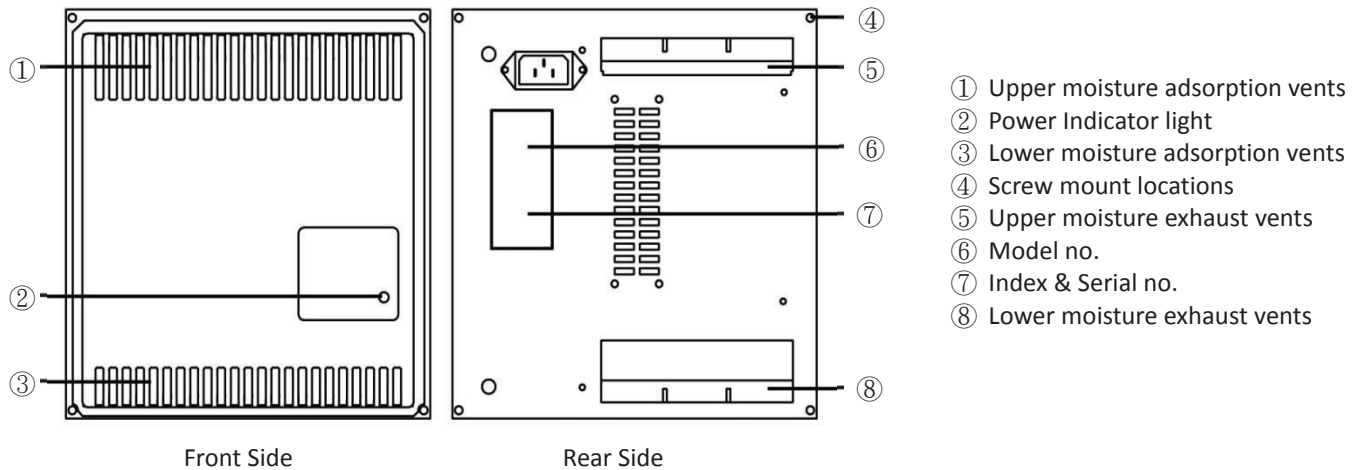

IV. STATPRO DRY CABINET INSTALLATION AND ADJUSTMENT

A. GENERAL INSTALLATION & OPERATION

1. Please find a flat and stable location for your STATPRO DRY CABINET.
2. Please control the indoor environment within 25°C ($\pm 2^{\circ}\text{C}$) & 55% ($\pm 5\%\text{RH}$), in order to allow the STATPRO DRY CABINET to function at its best performance.
3. Please maintain at least 5 cm distance between the back of the STATPRO DRY CABINET and the wall or other objects.
4. If your model is CPDC-1D/CPDC-2D, adjust the 4 pieces of “Adjustable Leveling Support” to make sure the cabinet is level.
5. If your model is CPDC-3D/CPDC-6D, set the casters’ brakes, then adjust the 4 pieces of “Adjustable Leveling Support” to make sure the cabinet is level.
6. Install 4 shelf clips at the desired height and place one shelf on these clips. Repeat the same method for other shelves. If your model is CPDC-6D, for shelf installation, please refer to “IV. B. REMOVING MIDDLE PILLAR AND SHELF INSTALLATION”
7. Connect one end of the anti-static grounding wire to “the Connecting Button for Anti-static Grounding Wire” on the back of the cabinet. Connect the other side of the grounding wire to your factory’s grounding location.
8. Plug power cord in an independent socket with proper voltage to begin operation.
9. STATPRO DRY CABINET will begin operating automatically. The power indicator light of STATPRO DRY CABINET Automatic Drying System (core unit) will light on.
10. During initial operation, it may take 24 to 48 hours for the STATPRO DRY CABINET to reach $<5\%\text{RH}$.
11. The DRY CABINET’s performance can be monitored real-time from the digital thermo-hygrometer.
12. When the RH displayed on the digital thermo-hygrometer has reached $<5\%\text{RH}$, items can be placed in the STATPRO DRY CABINET for protective storage.

B. REMOVING CENTER STILE AND SHELF INSTALLATION

1. Open both doors at the same level. The removable center stile appears. (pic. 1)
2. On the back of the removable center stile there is a white plastic latch (referred as the Latch below) (pic. 2 & pic. 3)
3. Please pull the Latch down. While holding the Latch in down position with one hand, use the other hand to gently push the removable center stile from outside to inside of the cabinet. The top of the removable center stile will separate from the cabinet. (pic. 3 & pic. 4)
4. Pull the removable center stile up and separate it from the cabinet. (pic. 4)
5. Install 4 pieces of shelf clips at the same height and place one shelf on the clips. Repeat the same method for the other shelves. (pic.5)
6. When all shelves has been installed at desired height, install the middle pillar back on the cabinet by following step 1 ~ 4 in reverse order. (pic. 6)

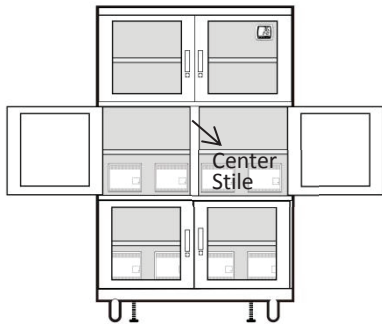

Pic.1

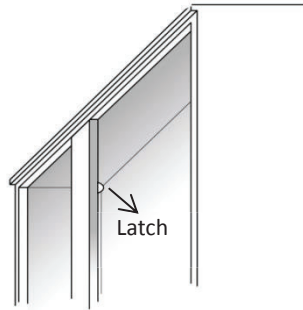

Pic.2

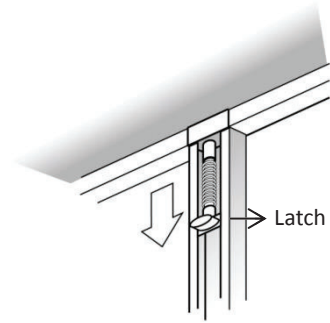

Pic.3

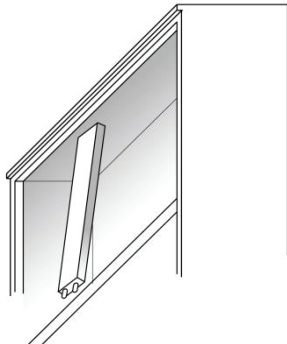

Pic.4

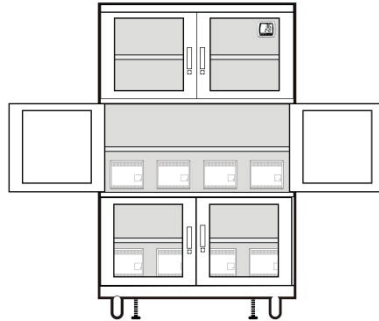

Pic.5

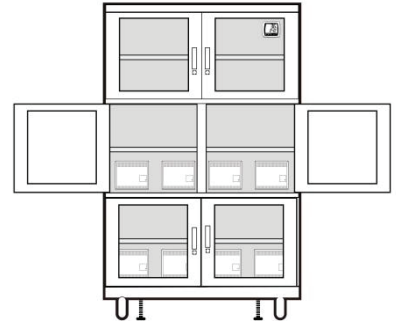

Pic.6

C. MANUAL NITROGEN PURGE SYSTEM (Optional feature)

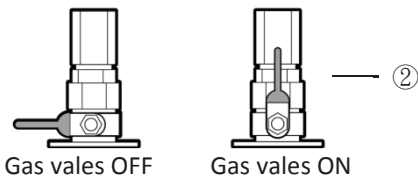
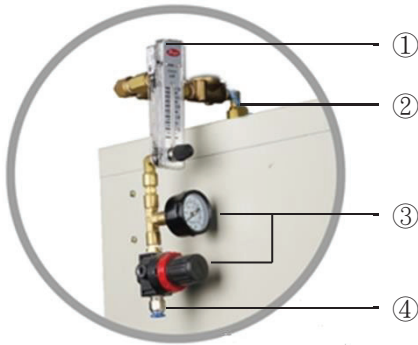

- ① **Flow regulator:**
Controlling gas flow. Manual control nitrogen purge.
Default setting: 0 L/min
Suggest setting: 80 L/min
- ② **Valves:**
To close the valve, turn handle perpendicular to the pipeline. To open the valve, turn handle parallel to the pipeline.
- ③ **Pressure Regulator:**
To control gas back pressure
(Client gas supply pressure must be below 10kgf/cm²)
Default setting: 0 kg/cm²
Suggest setting: 5 kg/cm²
- ④ **Gas inlet**

NOTE: Upon applying power and purge system for the first time, please re-adjust settings according to the environment.

1. **Pressure regulator adjustment:**
If adjustment is required, first, pull out the pressure regulator knob in the direction as shown with arrow. Then, adjust the gas pressure by turning clockwise to increase the pressure, counter clockwise to decrease the pressure. When adjustment is complete, push the pressure regulator knob back into the regulator. (Pic. 12)
2. **Flow regulator adjustment:**
Flow setting can be adjusted by turning the adjustment knob, clockwise to increase the flow, counter clockwise to decrease the flow or stop purging. (Pic. 13)

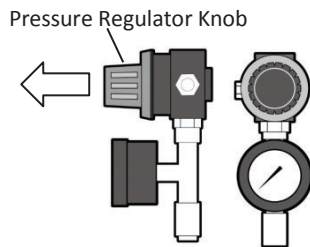

Pic.12

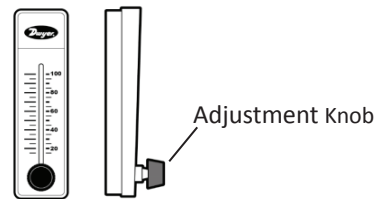

Pic.13

V. DIGITAL THERMO-HYGROMETER BATTERY REPLACEMENT

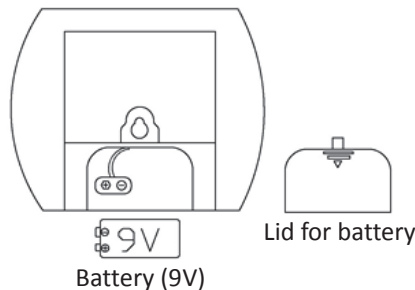
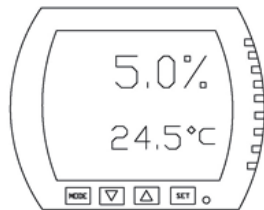

- A. The Digital Thermo-Hygrometer uses a 9V battery. The average life span of a 9V battery is about one year. When the battery symbol appears on the screen, please replace with a new battery by opening the back lid.

NOTE: The recommended brand and model of the battery is GP –SUPERCELL-SUPER HEAVEY DUTY, 9V. If GP's battery is not available, please replace with a battery of the same grade.

D. NAMES AND FUNTIONS OF NITROGEN CONTROLLER 'S FRONT PANEL PARTS

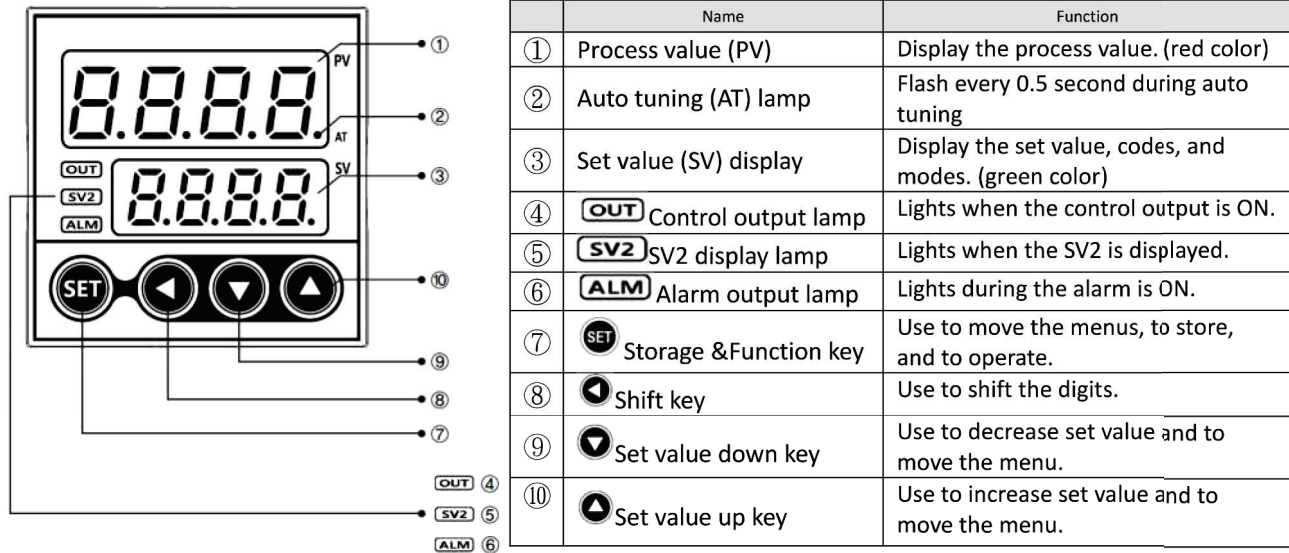

Manual Keypad Setting

1. Press and hold " **SET** " for 3 seconds to enter or exit LEVEL 1 menu.
2. To program Level 0 ~2 Parameter settings:
 - a. Press " **SET** " key to change to desired parameter setting position.
 - b. Press " ◀ SHIFT key " and set parameter will begin flashing.
 - c. Press " ▲ Value UP " or " ▼ Value DOWN " keys to change to desired setting.
 - d. Press " **SET** " key to program the value.
 - e. To continue to next setting press " **SET** " key.
3. To program "SET VALUE":
 - a. Press " **SET** " and "SV" will begin flashing.
 - b. Press " ◀ SHIFT key " to shift the digits, and press " ▲ Value UP " or " ▼ Value DOWN " keys to set the desired value.
 - c. Press " **SET** " key to program the desired setting.
4. If no buttons are pressed within 50 seconds during programming, the Control Panel will return to normal operation.
5. To program "boundary condition" for SET VALUE :
 - a. Press and hold " **SET** " for 3 seconds to enter or exit LEVEL 1 menu.
 - b. Press " **SET** " to select "HYS"
 - c. Press " **SET** " and "SV" will begin flashing.
 - d. Press " ◀ SHIFT key " to shift the digits, and press " ▲ Value UP " or " ▼ Value DOWN " keys to set "SV" in desired value.
 - e. Press " **SET** " key to program the desired setting.

Example: SET VALUE : 30, BOUNDARY VALUE: 1.00,

This means Setting between 29 -30; N₂ purging when RH ≥ 30%, N₂ purge stop RH < 29%

Error Code Chart

B.OUT : INPUT SENSOR error or burn out etc.

SYS.E : SYSTEM setting error or Memory damage (request for repair)

RJC.E : RJC Sensor damage or PCB burn (request for repair)

EEP.E : EEPROM damage (request for repair)

VI. TROUBLESHOOTING

A. **Problem:** The cabinet doors cannot be closed smoothly.

Possible Cause & Solutions:

1. The cabinet is not completely level. Please adjust the 4 pieces of “Adjustable Leveling Support”.
2. The cabinet might be impinged, which causes the cabinet distortion. Please contact your local representative for further repairing.

B. **Problem:** The RH is above normal range (>5%RH).

Possible Cause & Solutions:

1. Verify the power cord is connected properly.
2. Verify the doors are closed properly.
3. Verify whether the doors were opened within 30 min. If yes, please check the RH range after 30 min.
4. Verify whether power indicator is on. If the power indicator light is off, please contact your local representative for further diagnostic/repair.

Note: The humidity level inside the dry cabinet is affected by the relative humidity of ambient environment and the items/materials stored inside the cabinet. If the items stored inside the cabinet contains higher moisture content, the moisture inside the cabinet will require more time to be adsorbed. The RH levels inside the cabinet will never exceed the RH levels of the ambient environment because the cabinet does not have humidifier capability.

VII. SPECIFICATION

Model No.	CPDC-1D	CPDC-2D	CPDC-3D	CPDC-6D
RH Control Range:	≤5%RH			
Fast Recovery Time:	Down to ≤5%RH within 30 min. after open a door in 30 sec and close it. (Empty Cabinet Testing)			
Cabinets:	Anti-Static Painting, Anti-Static Glass, Anti-Static Stands / Casters, 1MΩ Ground wire			
Voltage:	110V or 220V			
Hygrometer:	Standalone Monitor System, TESTO digital thermo-hygrometer			
External Dimensions: (W x H x D) (cm)	40.0 X 74.0 X 45.5	88.0 X 90.0 X 58.0	60.0 X 193.0 X 71.0	120.0 X 193.0 X 71.0
Internal Dimensions: (W x H x D) (cm)	36.0 X 59.7 X 35.7	83.0 X 79.0 X 48.0	56.0 X 174.0 X 61.0	110.0 X 174.0 X 61.0
Capacity: (Liter)	93	372	672	1314
Shelves: (pcs)	2	3	5	5

Note: The specification above is tested under 25°C, 60%RH environment.